

A13B12HTBF00

AC axial fans

> CONTACT US



Axial fans provide forced-air cooling solution to temperature-sensitive applications. Compact fans with AC shaded pole or capacitor and DC brushless motor are designed for ventilation and spot cooling of internal machinery components, especially in areas in confined spaces. Available also versions tested to withstand harsh environmental conditions (IP55, IP68, all metal and HTR fans).

Technical data		
APPROVALS		
Approvals	CE; cURus	
PERFORMANCE		
Max Airflow	175/204 103/120	m ³ /h CFM
Max Static Pressure	72/27 0.29/0.11	Pa in H ₂ O
RPM	2700/3000	RPM
ELECTRICAL DATA		
Rated Voltage	115	V a.c.
Rated Current	0.2/0.16	A
Rated Power	14/12	W
Operating Voltage	103-126	V a.c.
Frequency	50/60	Hz
Appliance Class	I	
Insulation Class	B	
Motor Protection	Impedance Protected	
MECHANICAL DATA		
Bearing	Ball Bearing	
GENERIC DATA		
Casing Material	Die-Casting Aluminium	
Airflow Direction	Air exhaust over brackets	

Image is for illustrative purpose only. All specifications, data and drawing are subject to change without notice. Please refer to our terms of sales including our warranty and limited liabilities clauses.

A13B12HTBF00

AC axial fans

> CONTACT US

VENTILATION SYSTEMS

Technical data		
Electrical Connection	Fast-On 3x0,5mm	
Life Expectancy	40000	h at 40 °C
	40000	h at 104 °F
Fan Noise	46/50	dB(A)
Fixing System	Screws	
ENVIRONMENTAL AND THERMAL DATA		
IP Protection Degree	IP44	
Operating Temperature	-40÷70	°C
	-40÷158	°F
Storage Temperature	-40÷80	°C
	-40÷176	°F
UL DATA		
UL File Number Recognized Component	E223195	

Image is for illustrative purpose only. All specifications, data and drawing are subject to change without notice. Please refer to our terms of sales including our warranty and limited liabilities clauses.

A13B12HTBF00

AC axial fans

> CONTACT US

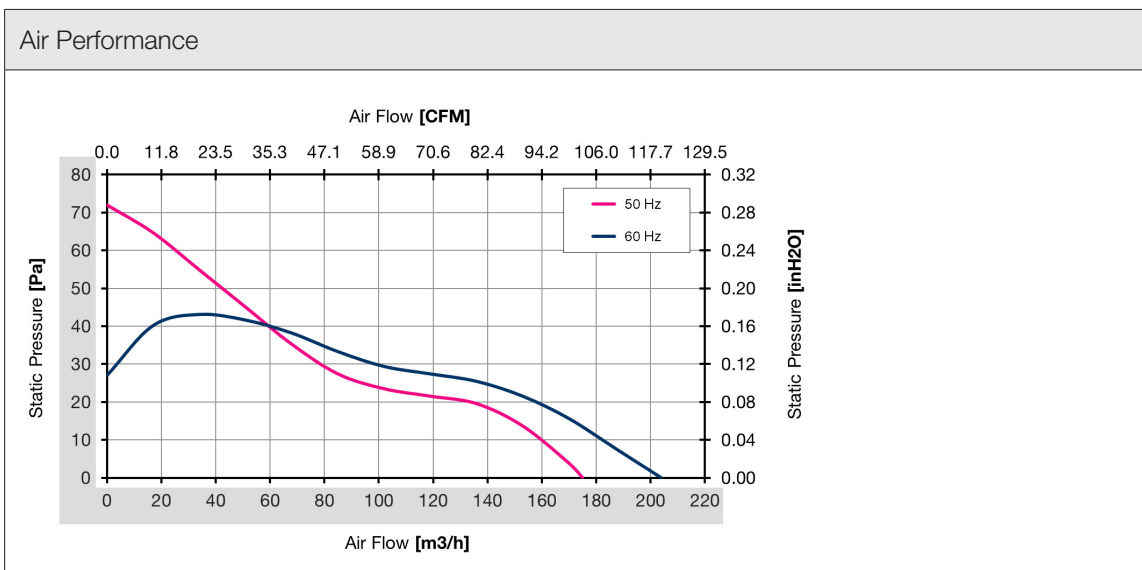
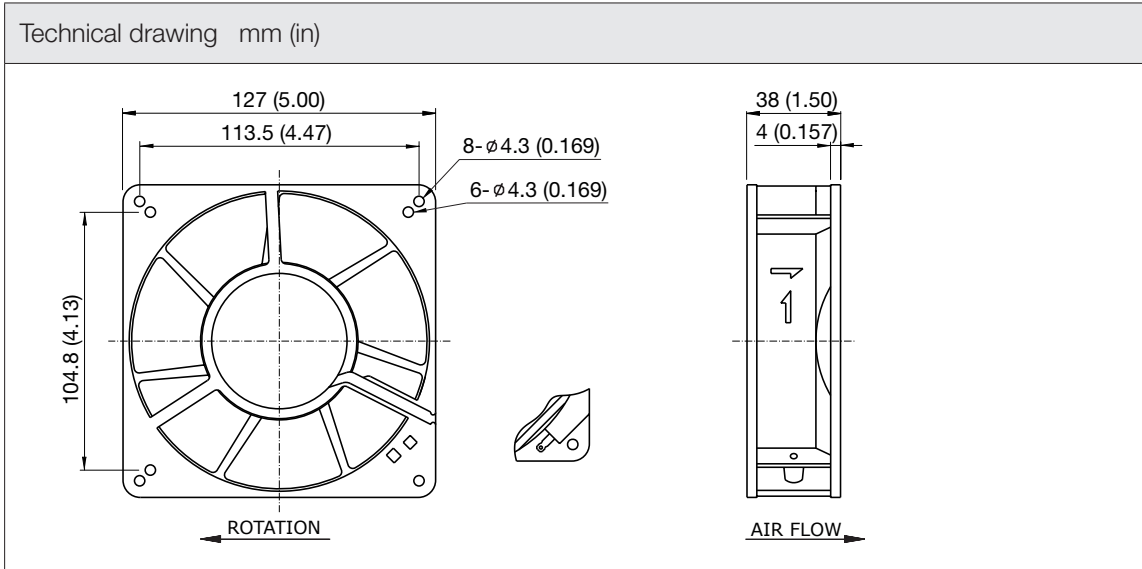

Image is for illustrative purpose only. All specifications, data and drawing are subject to change without notice. Please refer to our terms of sales including our warranty and limited liabilities clauses.