

Automotive Relays  
**CP RELAYS**

Product Catalog

**IN Your  
Future**

# CP RELAYS

## Compact Flat Size Relay for Automotive

< Protective construction >  
Sealed

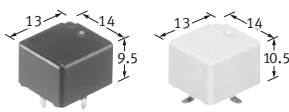

(Unit: mm)

### FEATURES

- Compact flat type  
<Height> PC board terminal type: 9.5 mm
- Compact and High capacity (25 A) continuous current (at 20°C)
- Simple footprint pattern enables ease of PC board layout
- "PC board terminal" and "Surface mount terminal" types available.
- Model available for wiper load.

### TYPICAL APPLICATIONS

- Powered windows, Automatic door locks, Powered sunroof, Memory seat, Wiper and Defogger, etc.

### ORDERING INFORMATION (PART NO. : Ordering part number for Japanese market)

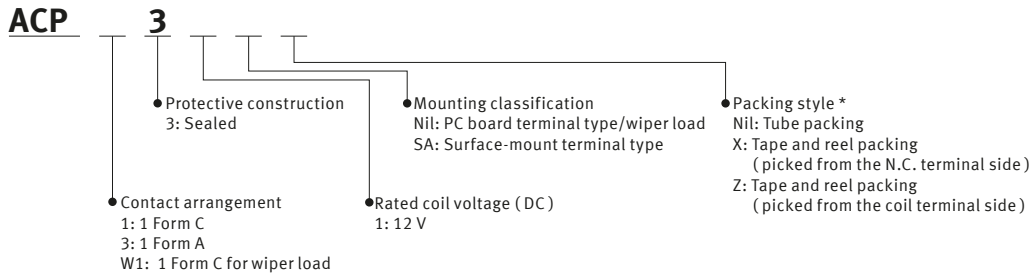

\* Surface mount terminal type is only supplied in tape and reel packaging. Tube packaging is only available for PC board type.

### ORDERING INFORMATION (TYPE NO. : Ordering part number for non Japanese market)

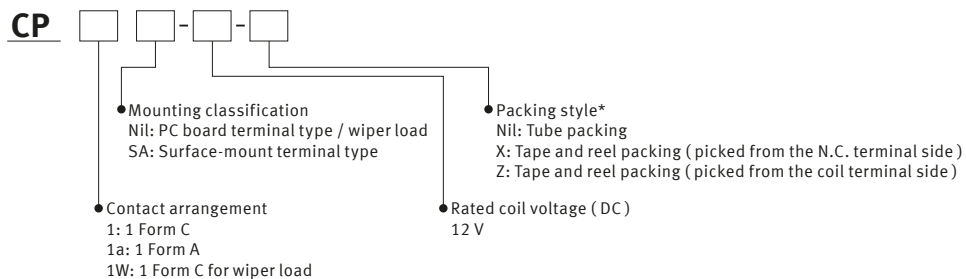

Note: \* Surface mount terminal type is only supplied in tape and reel packaging. Tube packaging is only available for PC board type.

# Automotive Relays CP RELAYS

## TYPES

" Type No. " is ordering part number for non Japanese market. " Part No. " is ordering part number for Japanese market.

### ■ PC board terminal type

Contact arrangement	Rated coil voltage	Type No.	Part No.	Packing	
				Carton (1-tube)	Case
1 Form A	12 V DC	CP1a-12V	ACP331	40 pcs.	1,000 pcs.
1 Form C		CP1-12V	ACP131		
1 Form C for wiper load		CP1W-12V	ACPW131		

### ■ Surface mount terminal type

Contact arrangement	Rated coil voltage	Type No.	Part No.	Packing	
				Carton (1-reel)	Case
1 Form C	12 V DC	CP1SA-12V-X	ACP131SAX	300 pcs.	900 pcs.
		CP1SA-12V-Z	ACP131SAZ		

Notes: 1. Surface mount terminal type is available only for 1 form C contact arrangement.

2. Surface mount terminal type is only supplied in tape and reel packaging. Tube packaging is only available for PC board type. Tape and reel packing symbol "X" or "Z" are not marked on the relay.

## RATING

### ■ Coil data

Rated coil voltage	Operate voltage (at 20°C) (initial)	Release voltage (at 20°C) (initial)	Rated operating current [±10%] (at 20°C)	Coil resistance [±10%] (at 20°C)	Rated operating power (at 20°C)	Usable voltage range (at 85°C)
12 V DC	Max. 7.2 V DC	Min. 1.0 V DC	53.3 mA	225 Ω	640 mW	10 to 16 V DC

Note: Other operate voltage types are also available. Please inquire our sales representative for details.

# Automotive Relays CP RELAYS

## ■ Specifications

### 1) Standard CP relay

Item		Specifications
Contact data	Contact arrangement	1 Form A, 1 Form C
	Contact resistance (initial)	Max. 100 mΩ (N.O. side: typ. 6 mΩ, N.C. side: typ. 8 mΩ) (By voltage drop 1 A 6 V DC)
	Contact voltage drop (initial)	N.O. side: Max. 0.2 V (at 10 A 12 V DC) N.C. side: Max. 0.2 V (at 10 A 12 V DC)
	Contact material	Ag alloy
	Rated switching capacity (resistive)	N.O. side: 20 A 14 V DC, N.C. side: 10 A 14 V DC
	Max. carrying current <sup>*1 *4</sup>	N.O. side: 40 A/2 min, 30 A/1 hour (Coil applied voltage 12 V DC, at 20°C) 35 A/2 min, 25 A/1 hour (Coil applied voltage 12 V DC, at 85°C)
	Min. switching load (resistive) <sup>*2</sup>	1 A 14 V DC (at 20°C)
Insulated resistance (initial)		Min. 100 MΩ (at 500 V DC, Measurement at same location as "Dielectric strength" section.)
Dielectric strength (initial)	Between open contacts	500 Vrms for 1 min (Detection current: 10 mA)
	Between contacts and coil	500 Vrms for 1 min (Detection current: 10 mA)
Time characteristics (initial)	Operate time (at rated voltage)	Max. 10 ms (at 20°C, without contact bounce time)
	Release time (at rated voltage)	Max. 10 ms (at 20°C, without contact bounce time) (without diode)
Shock resistance	Functional	Min. 100 m/s <sup>2</sup> (Half-wave pulse of sine wave: 11 ms, detection time: 10 μs)
	Destructive	Min. 1,000 m/s <sup>2</sup> (Half-wave pulse of sine wave: 6 ms)
Vibration resistance	Functional	10 to 100 Hz, Min. 44.1 m/s <sup>2</sup> (Detection time: 10 μs)
	Destructive	10 to 500 Hz, Min. 44.1 m/s <sup>2</sup> Time of vibration for each direction; X, Y direction: 2 hours, Z direction: 4 hours
Expected life	Mechanical	Min. 10 <sup>7</sup> (at 120 times/min)
	Electrical <sup>*4</sup>	<Resistive load> Min. 10 <sup>5</sup> (at rated switching capacity, operating frequency: 1 s ON, 9 s OFF) <Motor load> Min. 2 x 10 <sup>5</sup> (N.O. side: inrush 25 A, steady 5 A at 14 V DC) Min. 10 <sup>5</sup> (N.O. side: 20 A 14 V DC at motor lock) Min. 2 x 10 <sup>5</sup> (N.C. side: 20 A 14 V DC at break current) (operating frequency: 0.5 s ON, 9.5 s OFF)
Conditions	Conditions for usage, transport and storage <sup>*3</sup>	Ambient temperature: -40 to +85°C, Humidity: 5 to 85% RH (Avoid icing and condensation)
Weight		Approx. 4 g

Notes: \*1. Depends on connection conditions. Also, this does not guarantee repeated switching. We recommend that you confirm operation under actual conditions.

\*2. This value can change due to the switching frequency, environmental conditions, and desired reliability level, therefore it is recommended to check this with the actual load.

\*3. The upper operation ambient temperature limit is the maximum temperature that can satisfy the coil temperature rise value. For details, please refer to the "Automotive Relay Users Guide".

Please inquire if you will be using the relay in a high temperature atmosphere (110°C).

\*4. For wiper motor load, please see the wiper load specifications, below.

### 2) For wiper load (ACPW131)

Anything outside of that given below complies with standard CP relays.

Item		Specifications
Contact data	Max. carrying current (initial) <sup>*1</sup>	N.O. side: 25 A/1 min, 15 A/1 hour (coil applied voltage 12 V DC, at 20°C)
Expected life	Electrical life	<Wiper motor load (L = approx. 1 mH, without capacitor)> N.O. side: Min. 5 x 10 <sup>5</sup> (inrush 25 A, steady 6 A at 14 V DC) N.C. side: Min. 5 x 10 <sup>5</sup> (12 A 14 V DC at brake current) (operating frequency: 1 s ON, 9 s OFF)

Note: \*1. Depends on connection conditions. Also, this does not guarantee repeated carrying. We recommend that you confirm operation under actual conditions.

## REFERENCE DATA

### 1-1. Coil temperature rise (at room temperature)

Sample: CP1-12 V, 3 pcs  
 Point measured: Inside the coil  
 Carrying current: 5 A, 10 A, 15 A, 20 A  
 Ambient temperature 26°C

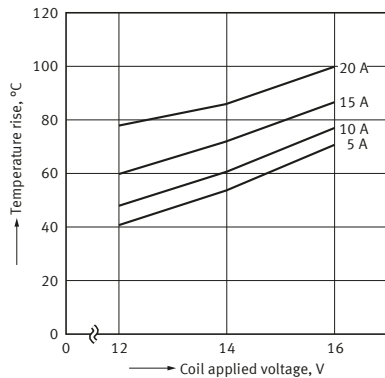

### 1-2. Coil temperature rise (at 85°C)

Sample: CP1-12 V, 6 pcs  
 Point measured: Inside the coil  
 Carrying current: 5 A, 10 A, 15 A, 20 A  
 Resistance method, ambient temperature 85°C

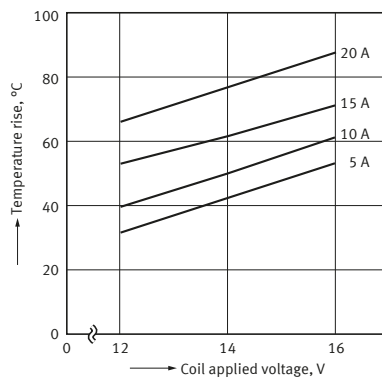

### 2. Max. switching capability (Resistive load, initial)

(N.O. side: room temperature)

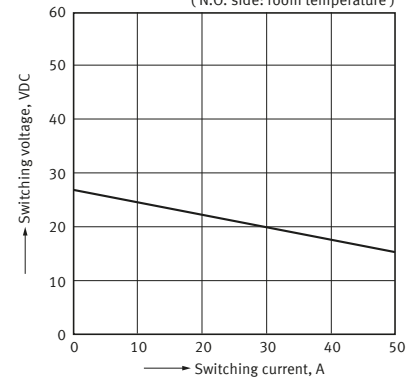

### 3. Ambient temperature and usable voltage range

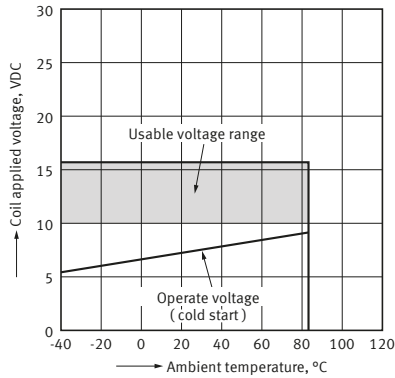

### 4. Distribution of operate and release voltage

Sample: CP1-12 V, 100 pcs  
 Ambient temperature: 20°C

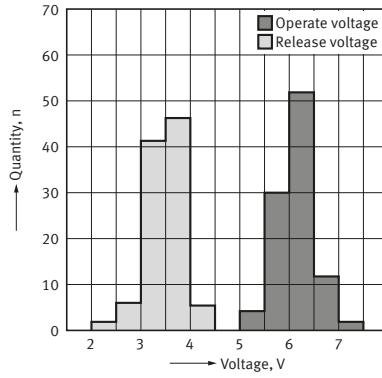

Sample: CP1-12 V, 100 pcs  
 Ambient temperature: 20°C

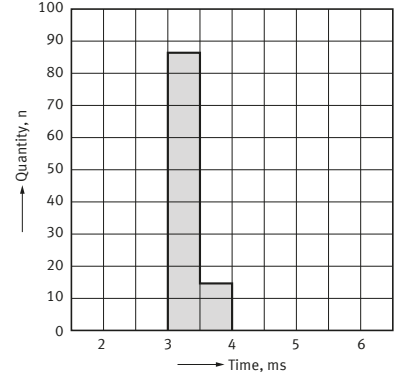

### 6. Distribution of release time

Sample: CP1-12 V, 100 pcs  
 Ambient temperature: 20°C

\* Without diode

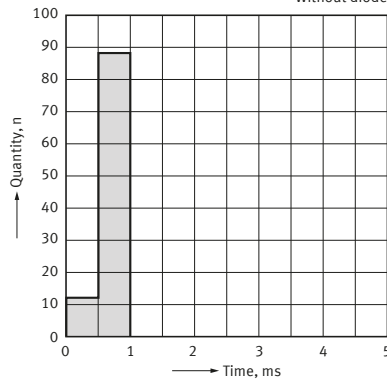

### 7-1. Electrical life test (Resistive load)

Sample: CP1-12 V  
 Quantity: n = 4 (N.C. = 2, N.O. = 2)  
 Load: Resistive load (N.C. side: 10 A 14 V DC, N.O. side: 20 A 14 V DC)  
 Operating frequency: ON 1 s, OFF 9 s  
 Ambient temperature: Room temperature

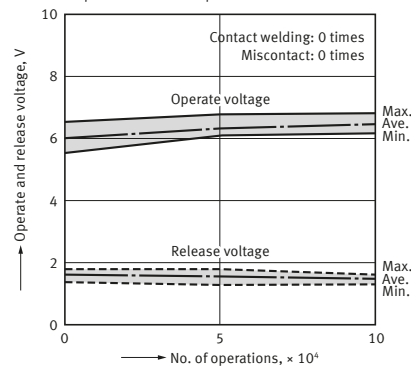

# Automotive Relays CP RELAYS

## 7-2. Electrical life test for wiper load (Motor free)

Sample: CP1W-12V  
 Quantity: n = 5  
 Load: N.O. side: Inrush 25 A, steady 6 A 14 VDC  
 Load: N.C. side: Brake current 12 A 14 VDC  
 Operating frequency: ON 1 s, OFF 9 s  
 Ambient temperature: Room temperature  
 Circuit:

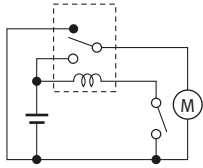

Change of operate and release voltage

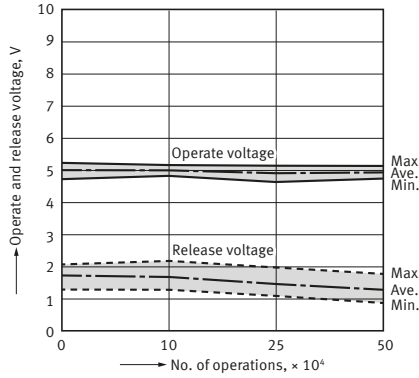

Change of contact resistance

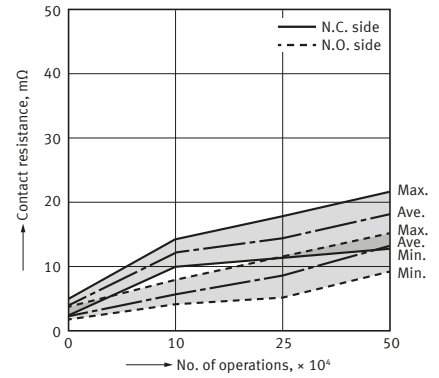

### DIMENSIONS

**CAD** The CAD data of the products with a "CAD" mark can be downloaded from our Website.

Unit: mm

### PC board terminal type

**CAD**



External dimensions

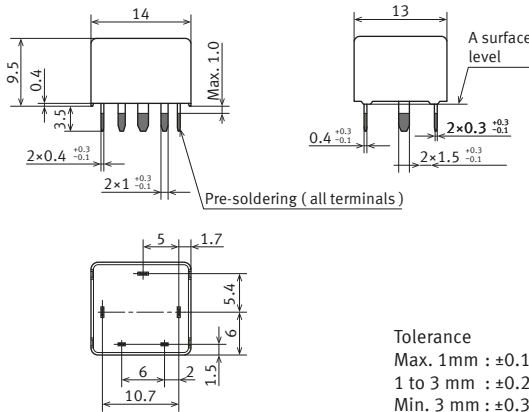

Tolerance  
 Max. 1mm : ±0.1  
 1 to 3 mm : ±0.2  
 Min. 3 mm : ±0.3

\* Dimensions (thickness and width) of terminal specified in this catalog is measured after pre-soldering. Intervals between terminals is measured at A surface level.

PC board pattern (BOTTOM VIEW)

1 Form A

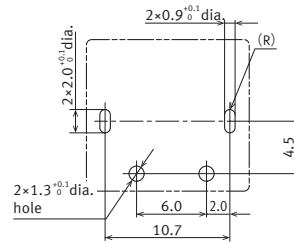

Tolerance: ± 0.1

1 Form C

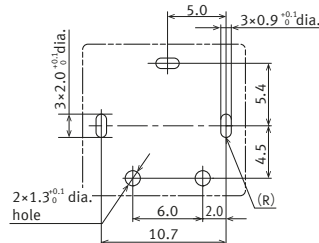

Tolerance: ± 0.1

Schematic (BOTTOM VIEW)

1 Form A

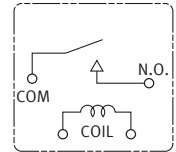

1 Form C

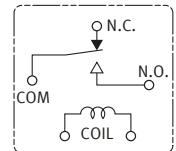

### Surface mount terminal type

**CAD**



External dimensions

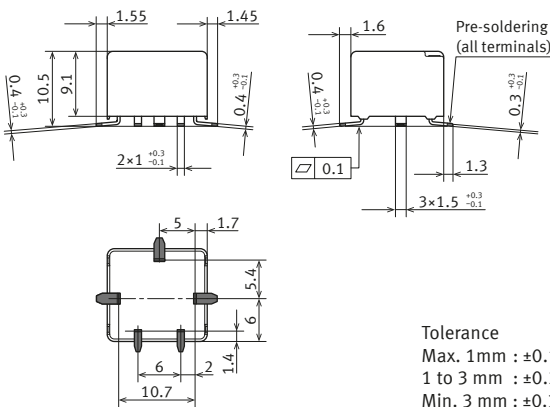

Tolerance  
 Max. 1mm : ±0.1  
 1 to 3 mm : ±0.2  
 Min. 3 mm : ±0.3

Recommendable mounting pad (TOP VIEW)

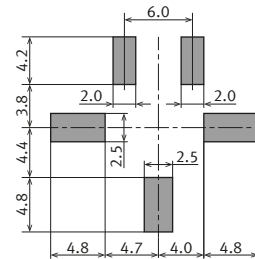

Tolerance: ± 0.1

Schematic (BOTTOM VIEW)

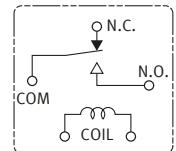

## GUIDELINES FOR USAGE

■ For general cautions for use, please refer to the "Automotive Relay Users Guide".

### ■ Precautions when using CP relays

#### ● Mounting and cleaning conditions for Surface-mount terminal type relays

When soldering this relay, please observe the following conditions.

(Recommended condition; Number of reflow: 1 time,  
Measurement location: terminal temperature)

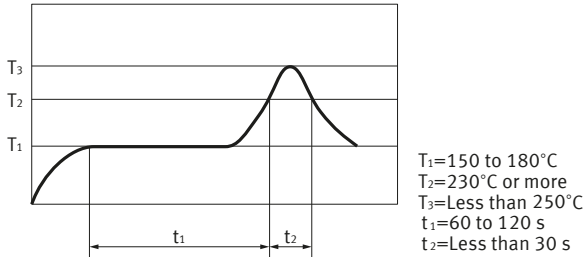

Temperature profile indicates the temperature of the soldered part (Note 1) of terminals on the surface of the PC board, however, for other areas such as the surface of relay case, make a setting so that you do not exceed the recommended conditions.

\*The temperature of the relay exterior and interior may be extremely high depending on the component density on the board, the heating method of the reflow oven or circuit board type.

#### ● Other cautions of reflow soldering

- (1) Reflow performance may be affected if you carry out soldering in a way that exceeds the recommended conditions. If you need to exceed the recommended conditions when soldering, please inquire our sales representative before using in an application.
- (2) Please confirm the heat stress of relay by using actual board because it may be changed by board condition or manufacturing process condition.
- (3) Solder creepage, wettability, or soldering strength will be affected by the changing of soldering condition or used solder type. Please check them under the actual production condition in detail.
- (4) Avoid cleaning (ultrasonic cleaning, boiling cleaning, etc.) and coating in order to prevent negative impacts on relay characteristics.

#### ● Storage condition after opening a moisture-prevention package

- (1) After opening a moisture-prevention package, use the item as soon as possible (within 4 days under an environment of Max.  $30^\circ\text{C}$ , Max. 70% RH).
- (2) If products are not used within 4 days after opening a moisture-prevention package, store them in a humidity controlled desiccator or in a storage bag with silica gel.

Please refer to "**the latest product specifications**" when designing your product.

•Requests to customers:

<https://industrial.panasonic.com/ac/e/salespolicies/>

■ Global Sales Network Information: [industrial.panasonic.com/ac/e/salesnetwork](https://industrial.panasonic.com/ac/e/salesnetwork)

---

**Panasonic**  
INDUSTRY

**Panasonic Industry Co., Ltd.**

Electromechanical Control Business Division

■ 1006, Oaza Kadoma, Kadoma-shi, Osaka 571-8506, Japan  
[industrial.panasonic.com/ac/e/](https://industrial.panasonic.com/ac/e/)