



RM85 for switching higher voltages

miniature relays



**SWITCHING
VOLTAGE
480 V AC**

- Relays designed for continuous operation*
- Contact gap: 0,6 mm
- CTI 250
- Reinforced insulation
- For PCB
- DC coils, insulation class F: 155 °C
- Compliance with standard EN 60335-1
- Recognitions, certifications, directives: RoHS,   

Contact data

Number and type of contacts		1 NO
Contact material		AgSnO₂
Rated / max. switching voltage	AC	250 V / 480 V
Min. switching voltage		10 V
Rated load (capacity)	AC1	5 A / 480 V AC
	AC15	3 A / 120 V
	DC1	16 A / 24 V DC
	DC13	0,22 A / 120 V
Motor load	acc. to UL 508	1/2 HP
	AC3 acc. to IEC 60947-4-1	0,5 kW
		240 V AC, 4,9 FLA, single-phase motor 
		240 V AC, single-phase motor
Min. switching current		10 mA
Max. make current		30 A
Rated current		16 A / 250 V AC
Max. breaking capacity	AC1	2 400 VA
Min. breaking capacity		1 W
Contact resistance		≤ 100 mΩ 100 mA, 24 V
Max. operating frequency	AC1	• at rated load
		• no load
		360 cycles/hour
		3 600 cycles/hour

Coil data

Rated voltage	DC	3, 5, 6, 9, 12 , 18, 24 , 36, 48, 60, 110 V
Must release voltage		≥ 0,1 U _n
Operating range of supply voltage		see Table 1
Rated power consumption	DC	0,4 ... 0,48 W

Insulation according to EN 60664-1

Insulation rated voltage		480 V AC
Rated surge voltage		4 000 V 1,2 / 50 μs
Overvoltage category		III
Insulation pollution degree		3
Dielectric strength	• between coil and contacts	5 000 V AC
	• contact clearance	2 000 V AC
		type of insulation: reinforced
		type of clearance: full-disconnection
Contact - coil distance	• clearance	≥ 10 mm
	• creepage	≥ 10 mm

General data

Operating / release time (typical values)		7 ms / 3 ms
Electrical life (number of cycles)	• resistive AC1	> 4 x 10 ⁴ 5 A, 480 V AC
	• motor load acc. to UL 508	10 ⁵ 5 FLA / 7 LRA, 240 V AC, 65 °C
		10 ⁵ 5 FLA / 12 LRA, 24 V DC, 65 °C
Mechanical life	3 600 cycles/hour	> 3 x 10 ⁷
Electromagnetic load according to UL 508		Heavy Pilot Duty 480 V AC, 15 A make / 1,5 A break
Dimensions (L x W x H)		29 x 12,7 x 15,7 mm
Weight		14 g
Ambient temperature	• storage	-40...+85 °C
	• operating	-40...+85 °C
Cover protection category		IP 40 or IP 67 EN 60529
Environmental protection		RTIII EN 61810-1
Shock resistance		30 g
Vibration resistance		10 g 10...150 Hz
Solder bath temperature		max. 270 °C
Soldering time		max. 5 s

The data in bold type relate to the standard versions of the relays. *The relays are designed for continuous operation while maintaining the parameters declared in the data sheet.  For single phase motors for 110-120 V AC do not use motors with higher FLA than given for 240 V AC.

RM85 for switching higher voltages miniature relays

Dimensions

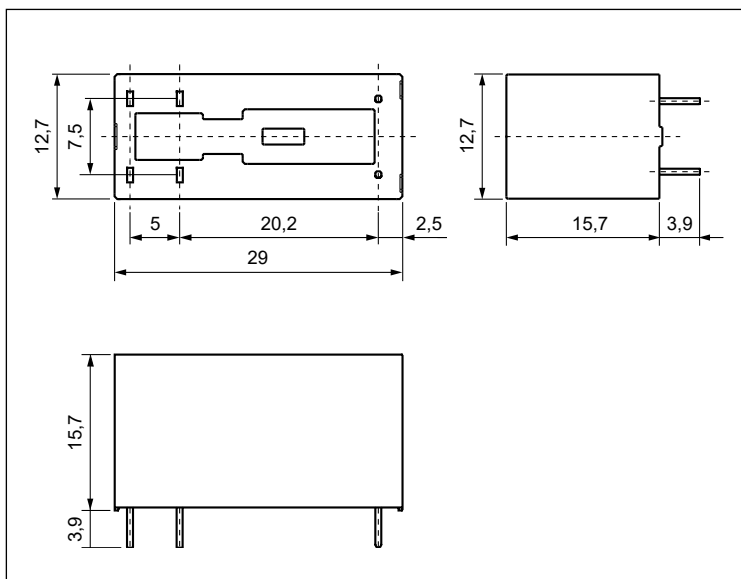

Pinout (solder side view)

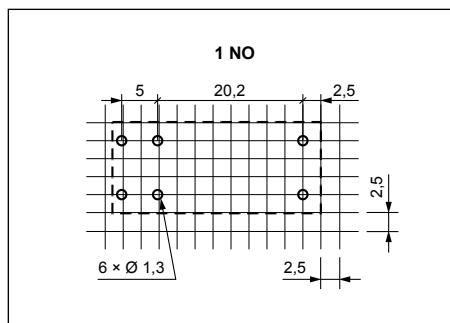

Mounting

Relays **RM85 for switching higher voltages** are designed for direct PCB mounting.

Connection diagram (pin side view)

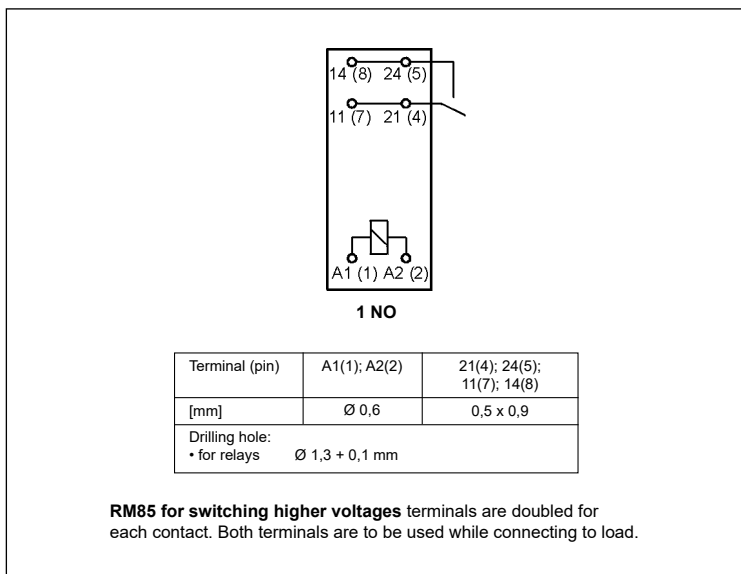

Interface relays PI84 (PI85)

set: relay RM84 (RM85)
+ socket GZT80
(GZM80, GZP80)



RM85 for switching higher voltages

miniature relays

Coil data - DC voltage version

Table 1

Coil code	Rated voltage V DC	Coil resistance at 20 °C Ω	Acceptable resistance	Coil operating range V DC	
				min. (at 20 °C)	max. (at 85 °C)
1003	3	22	± 10%	2,1	3,3
1005	5	60	± 10%	3,5	5,5
1006	6	90	± 10%	4,2	6,6
1009	9	200	± 10%	6,3	9,9
1012	12	360	± 10%	8,4	13,2
1018	18	710	± 10%	12,6	19,8
1024	24	1 440	± 10%	16,8	26,4
1036	36	3 140	± 10%	25,2	39,6
1048	48	5 700	± 10%	33,6	52,8
1060	60	7 500	± 10%	42,0	66,0
1110	110	25 200	± 10%	77,0	121,0

The data in bold type relate to the standard versions of the relays.

Ordering codes

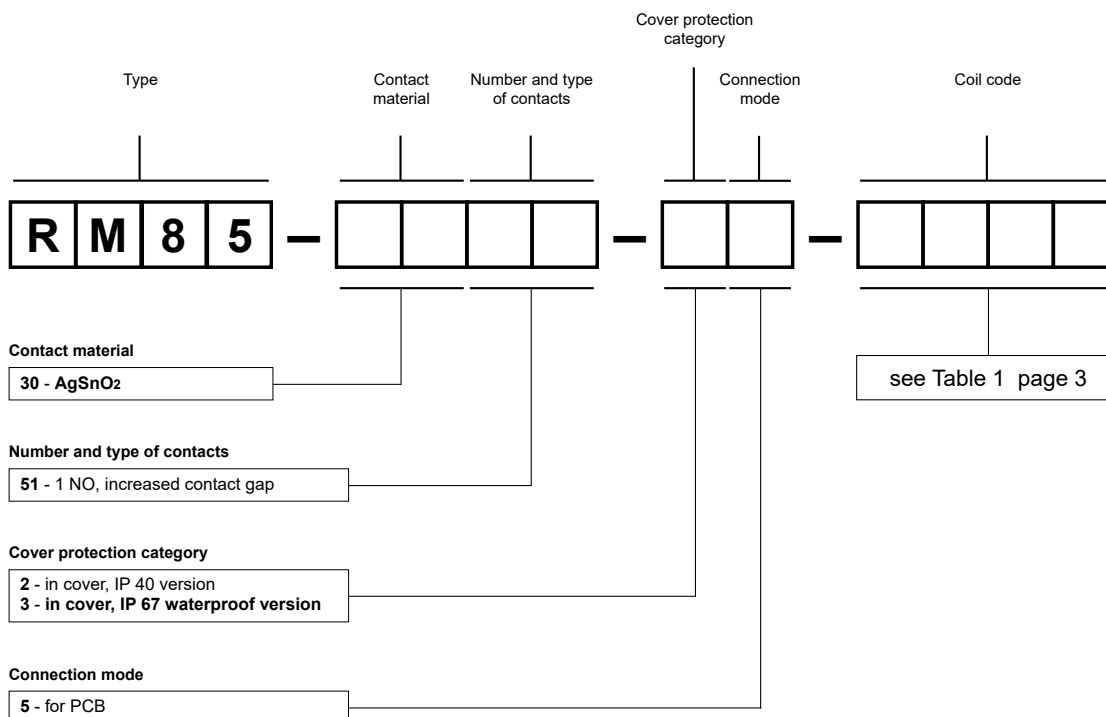

Example of ordering code:

RM85-3051-35-1012

relay **RM85**, with increased contact gap, for PCB, one normally open contact, contact material AgSnO₂, coil voltage 12 V DC, in cover IP 67

PRECAUTIONS:

1. Ensure that the parameters of the product described in its specification provide a safety margin for the appropriate operation of the device or system and never use the product in circumstances which exceed the parameters of the product. 2. Never touch any live parts of the device. 3. Ensure that the product has been connected correctly. An incorrect connection may cause malfunction, excessive heating or risk of fire. 4. In case of any risk of any serious material loss or death or injuries of humans or animals, the devices or systems shall be designed so to equip them with double safety system to guarantee their reliable operation.