

# RM96



## miniature relays

RM96 1 CO





RM96 1 NO / 1 NC



- Relays designed for continuous operation\*
- Height 16,2 mm • IP 40 and IP 67
- For PCB (1 CO, 1 NO, 1 NC) and plug-in sockets (1 CO)
- Accessories: sockets and modules for 1 CO
- DC coils, insulation class F: 155 °C
- Recyclable packing
- Terminals: 3,2 mm for version 1 CO,  
5,0 mm for version 1 NO and 1 NC
- Recognitions, certifications, directives: RoHS,   

### Contact data

Number and type of contacts	1 CO, 1 NO, 1 NC	
Contact material	<b>AgSnO<sub>2</sub></b> , AgSnO <sub>2</sub> /Au hard gold plating	
Rated / max. switching voltage	AC	250 V / 400 V
Min. switching voltage	10 V AgSnO <sub>2</sub> , 5 V AgSnO <sub>2</sub> /Au hard gold plating	
Rated load (capacity)	AC1	8 A / 250 V AC      10 A / 250 V AC (UL, VDE)
	AC15	3 A / 120 V      1,5 A / 240 V (B300)
	DC1	8 A / 24 V DC (see Fig. 3)
	DC13	0,22 A / 120 V      0,1 A / 250 V (R300)
Motor load	acc. to UL 508	1/2 HP      240 V AC, 4,9 FLA, single-phase motor 
	AC3 acc. to IEC 60947-4-1	0,37 kW      240 V AC, single-phase motor
Min. switching current	10 mA AgSnO <sub>2</sub> , 2 mA AgSnO <sub>2</sub> /Au hard gold plating	
Max. make current	15 A	
Rated current	8 A	
Max. breaking capacity	AC1	2 000 VA
Min. breaking capacity	1 W AgSnO <sub>2</sub> , 0,05 W AgSnO <sub>2</sub> /Au hard gold plating	
Contact resistance	≤ 100 mΩ	
Max. operating frequency	AC1	• at rated load      600 cycles/hour
		• no load      72 000 cycles/hour
<b>Coil data</b>		
Rated voltage	DC	5, 6, 9, <b>12</b> , 18, <b>24</b> , 48 V
Must release voltage	DC: ≥ 0,1 U <sub>n</sub>	
Operating range of supply voltage	see Table 1 and Fig. 4	
Rated power consumption	DC	0,22...0,3 W
<b>Insulation</b> according to EN 60664-1		
Insulation rated voltage	400 V AC	
Rated surge voltage	4 000 V    1,2 / 50 μs	
Overvoltage category	III	
Insulation pollution degree	3	
Dielectric strength	• between coil and contacts	4 000 V AC      type of insulation: reinforced
	• contact clearance	1 000 V AC      type of clearance: micro-disconnection
Contact - coil distance	• clearance	≥ 8 mm
	• creepage	≥ 8 mm
<b>General data</b>		
Operating / release time (typical values)	10 ms / 5 ms	
Electrical life (number of cycles)	• resistive AC1	> 10 <sup>5</sup> 8 A, 250 V AC
	• cosφ	see Fig. 2
Mechanical life (cycles)	> 2 x 10 <sup>7</sup>	
Dimensions (L x W x H)	1 CO:	30 x 10 x 16,2 mm
	1 NO, 1 NC:	28 x 10 x 16,2 mm
Weight	11 g	
Ambient temperature	• storage	-40...+85 °C
	• operating	-40...+80 °C
Cover protection category	IP 40 or <b>IP 67</b> EN 60529	
Environmental protection	RTII      EN 61810-1	
Shock resistance	20 g	
Vibration resistance	10 g 10...150 Hz	
Solder bath temperature	max. 270 °C	
Soldering time	max. 5 s	

The data in bold type relate to the standard versions of the relays. \*The relays are designed for continuous operation while maintaining the parameters declared in the data sheet.  For single phase motors for 110-120 V AC do not use motors with higher FLA than given for 240 V AC.

# RM96

## miniature relays

### Dimensions

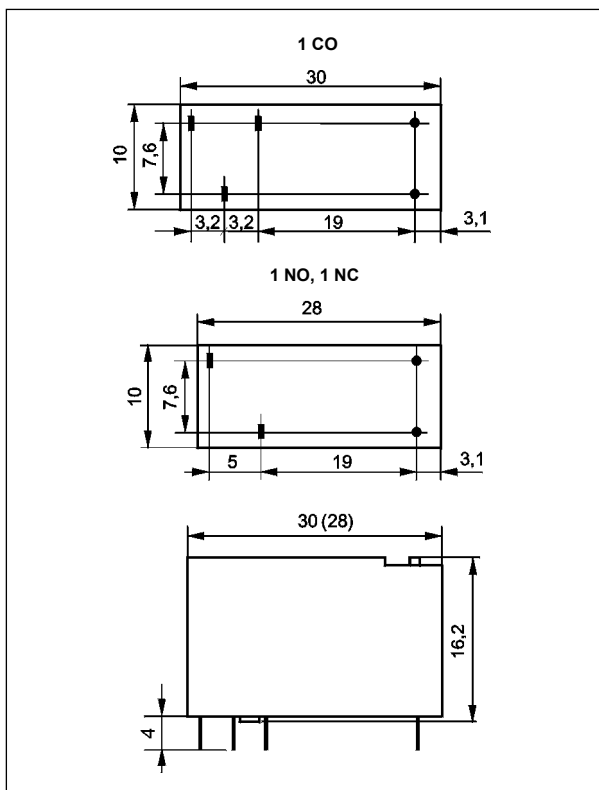

### Connection diagrams (pin side view)

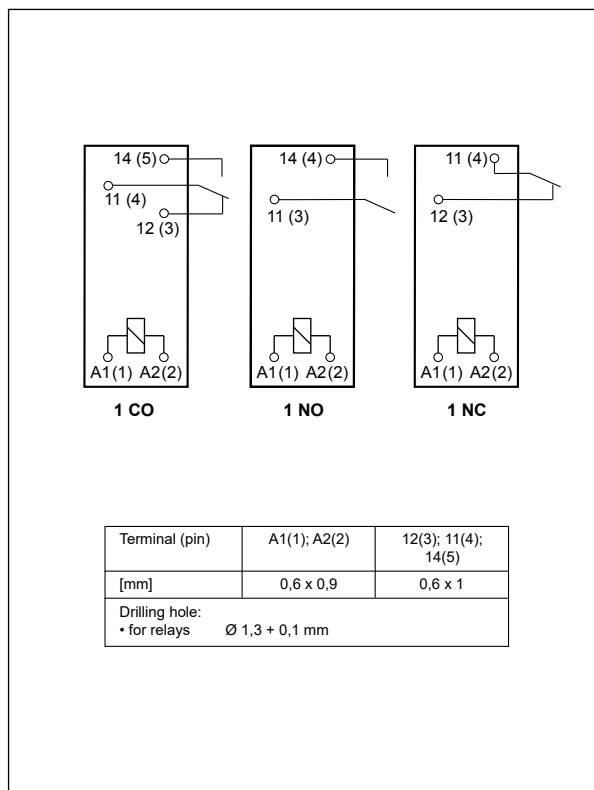

### Pinout (solder side view)

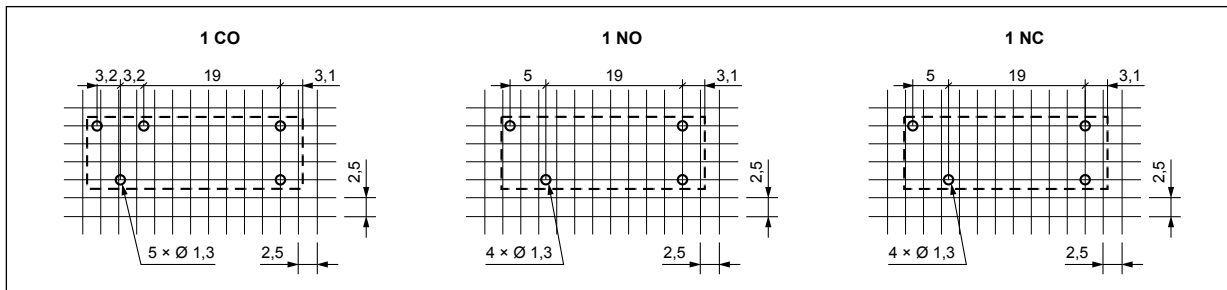

### Mounting

Relays **RM96 1 NO** (one normally open contact) and **RM96 1 NC** (one normally closed contact) are designed for direct PCB mounting.

Relays **RM96 1 CO** (one changeover contact) are designed for: • direct PCB mounting • plug-in sockets.

Sockets for RM96 1 CO	Accessories			Additional equipment
	Retainer / retractor clips	Spring wire clips	Description plates	
<b>Screw terminals sockets, 35 mm rail mount (acc. to EN 60715) or on panel mounting (one M3 screw)</b>				
ES 32	MS 16	GZM80-0041	TR	M... Ⓜ, ZGGZ80 Ⓜ

Ⓜ Signalling / protecting modules type M... - see page 6.

Ⓜ Interconnection strips ZGGZ80 - see page 7.

**Electrical life at AC resistive current.**  
 $U_n = 230 \text{ V AC}$  - version 1 NO

Fig. 1

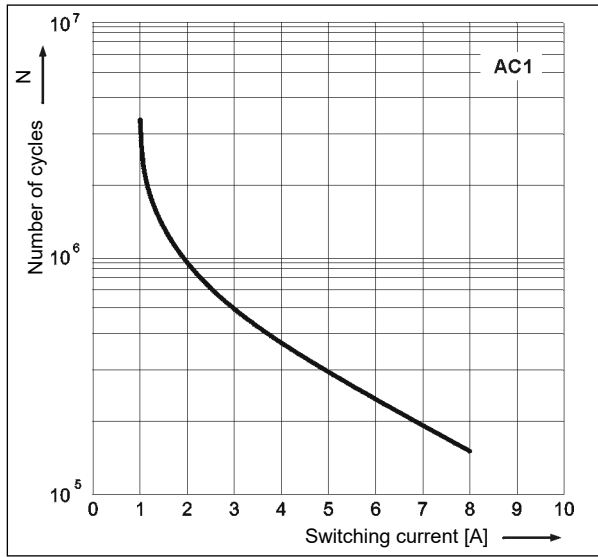

**Electrical life reduction factor at AC inductive load**

Fig. 2

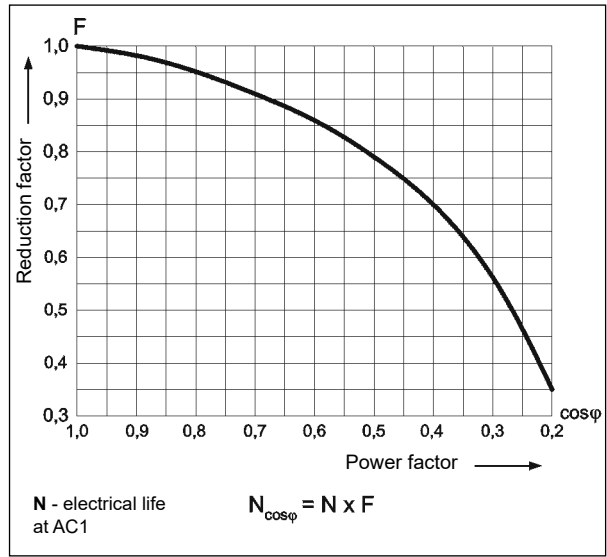

**Max. breaking capacity**  
**A - resistive load DC1**  
**B - resistive load AC1**

Fig. 3

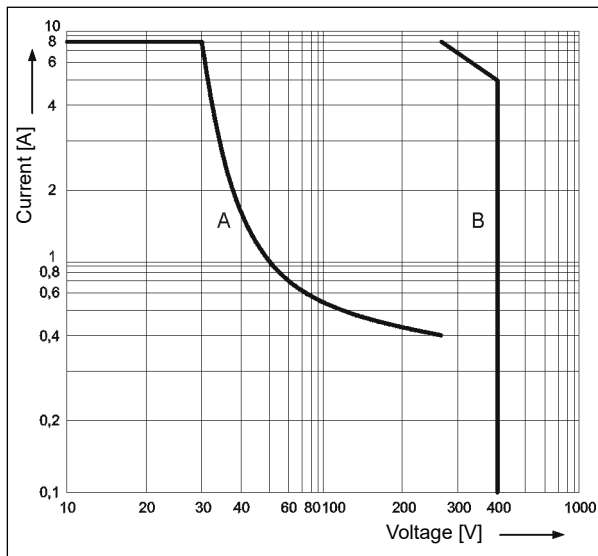

**Coil operating range - DC**

Fig. 4

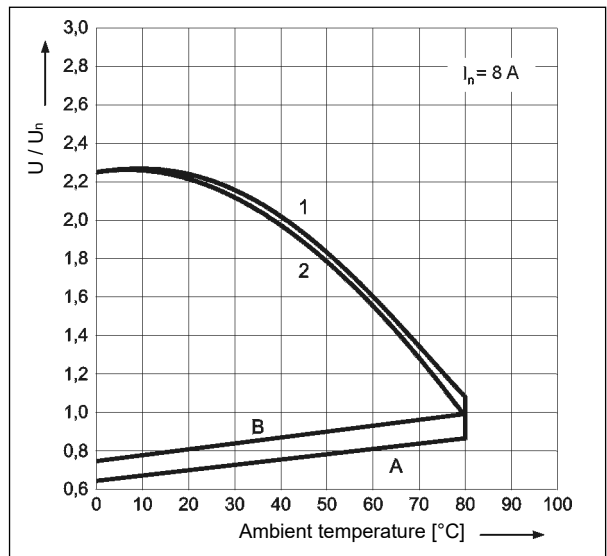

**Description of Fig. 4**

**A** - relations between make voltage and ambient temperature at no load on contacts. Coil temperature and ambient temperature are equal before coil energizing. Make voltage is not higher than the value read on Y axis (multiplication of rated voltage).

**B** - relations between make voltage and ambient temperature after initial coil heating up with  $1,1 U_n$ , at continues load of  $I_n$  on contacts. Make voltage is not higher than the value read on Y axis (multiplication of rated voltage).

**1, 2** - values on Y axis represent allowed overvoltage on coil at certain ambient temperature and contact load:

- 1** - no load
- 2** - rated load

# RM96

## miniature relays

Coil data - DC voltage version

Table 1

Coil code	Rated voltage V DC	Coil resistance at 20 °C Ω	Acceptable resistance	Coil operating range V DC	
				min. (at 20 °C)	max. (at 20 °C)
1005	5	110	± 10%	3,5	12,0
1006	6	160	± 10%	4,2	14,5
1009	9	360	± 10%	6,3	22,0
<b>1012</b>	<b>12</b>	<b>660</b>	<b>± 10%</b>	<b>8,4</b>	<b>29,5</b>
1018	18	1 500	± 10%	12,6	44,0
<b>1024</b>	<b>24</b>	<b>2 200</b>	<b>± 10%</b>	<b>16,8</b>	<b>54,0</b>
1048	48	8 000	± 10%	33,6	102,0

The data in bold type relate to the standard versions of the relays.

### Ordering codes

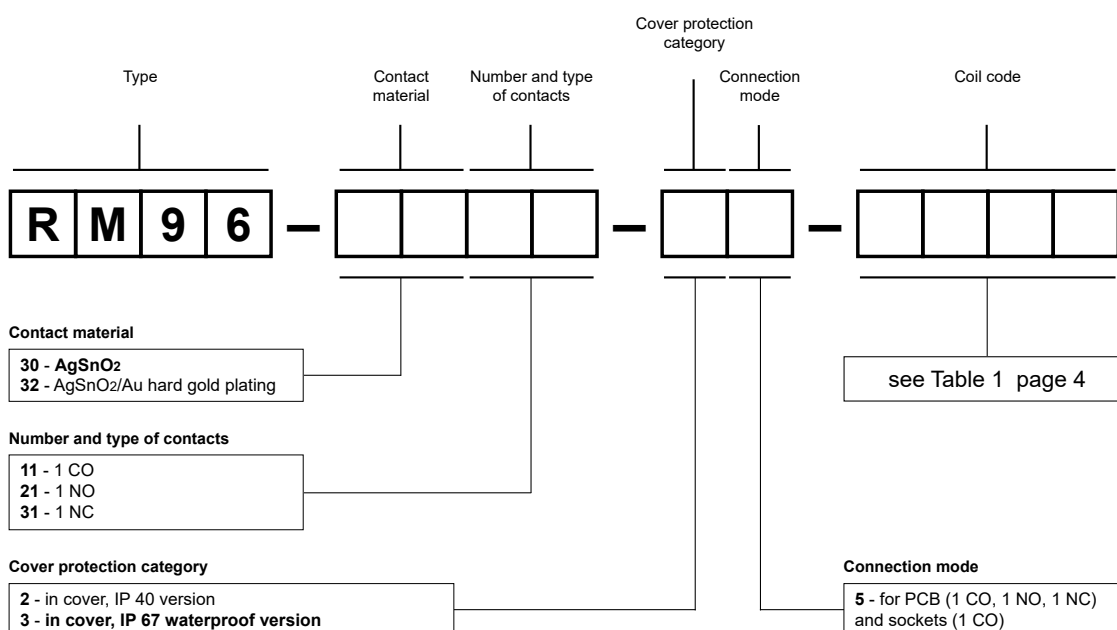

Examples of ordering codes:

**RM96-3011-35-1012**

relay **RM96**, for PCB and sockets, one changeover contact, contact material AgSnO<sub>2</sub>, coil voltage 12 V DC, in cover IP 67

**RM96-3021-25-1024**

relay **RM96**, for PCB, one normally open contact, contact material AgSnO<sub>2</sub>, coil voltage 24 V DC, in cover IP 40

### ES 32

Screw terminals  
plug-in sockets  
for RM96 1 CO  
- see page 5

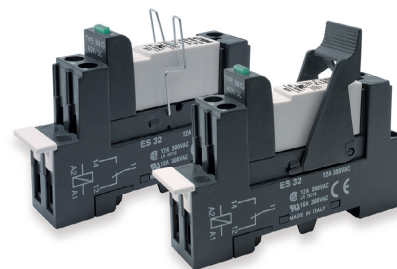

# Sockets and accessories

## ES 32

For RM96 1 CO

Screw terminals  
 Max. tightening moment  
 for the terminal: 0,5 Nm  
 35 mm rail mount  
 acc. to EN 60715  
 or on panel mounting  
 75 x 15,5 x 42,5(59) mm ②  
 One pole, 3,2 mm pinout  
 12 A, 300 V AC



### Connection diagrams

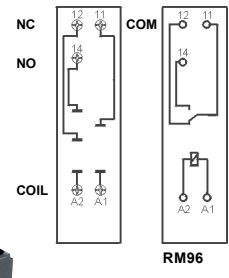

RM96

TR

Module type M...



ZGGZ80



GZM80-0041

### Accessories ①

### Dimensions

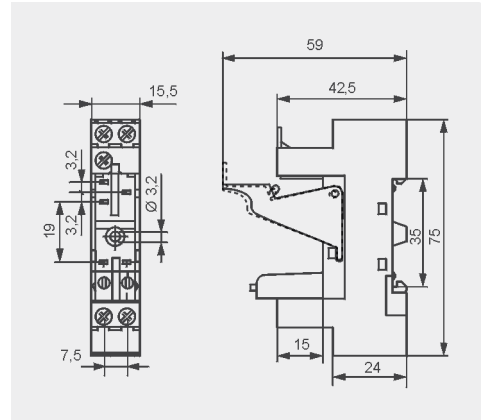

- ① Mounting and sub-assemblies of accessories in the socket - see page 5. Signalling / protecting modules type M... - see page 6.
- ② In the bracket the height of socket with retainer / retractor clip is shown.

## Mounting and sub-assemblies of the relay and accessories in the socket

Signalling / protecting module type M...



Retainer / retractor clip



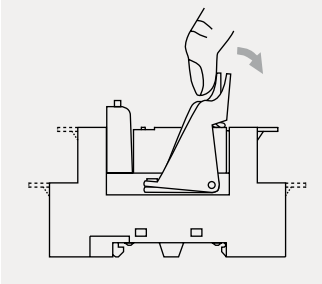

Removing the relay from the socket with a retractor / retractor clip





Electromagnetic relay



Description plate

Screw terminals plug-in socket





### PRECAUTIONS:

1. Ensure that the parameters of the product described in its specification provide a safety margin for the appropriate operation of the device or system and never use the product in circumstances which exceed the parameters of the product. 2. Never touch any live parts of the device. 3. Ensure that the product has been connected correctly. An incorrect connection may cause malfunction, excessive heating or risk of fire. 4. In case of any risk of any serious material loss or death or injuries of humans or animals, the devices or systems shall be designed so to equip them with double safety system to guarantee their reliable operation.

## Signalling / protecting modules type M...

### For sockets type:

GZT80, GZM80, GZS80, GZP80, GZT92, GZM92, GZS92, ES 32, GZT2, GZM2, GZT3, GZM3, GZT4, GZM4, GZP4

Modules type M... are parallelly connected with relay coil.

Polarization P: -A1/+A2. Polarization N: +A1/-A2.

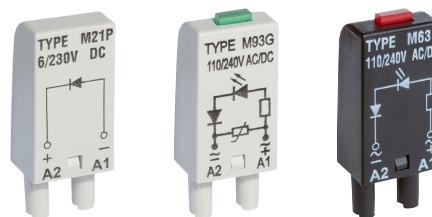

Modules type M...	Layout	Voltage	Type of module ① ②
<b>Module D (polarization P)</b> It limits overvoltage on DC coils.		6/230 V DC	M21P
<b>Module D (polarization N)</b> It limits overvoltage on DC coils.		6/230 V DC	M21N
<b>Module LD (polarization P)</b> It limits overvoltage on DC coils. Coil energizing indication.		6/24 V DC 24/60 V DC 110/230 V DC	M31R, M31G M32R, M32G M33R, M33G
<b>Module LD (polarization N)</b> It limits overvoltage on DC coils. Coil energizing indication.		6/24 V DC 24/60 V DC 110/230 V DC	M41R, M41G M42R, M42G M43R, M43G
<b>Module RC</b> It protects against EMC disturbance. It limits overvoltage.		6/24 V AC/DC 24/60 V AC/DC 110/240 V AC/DC	M51 M52 M53
<b>Module L</b> Coil energizing indication.		6/24 V AC/DC 24/60 V AC/DC 110/240 V AC/DC	M61R, M61G M62R, M62G M63R, M63G
<b>Module LV</b> It limits overvoltage on AC and DC coils. Coil energizing indication.		6/24 V AC/DC 24/60 V AC/DC 110/240 V AC/DC	M91R, M91G M92R, M92G M93R, M93G
<b>Module V</b> It limits overvoltage on AC coils. No indication.		6/24 V AC 110/130 V AC 220/240 V AC	M71 M72 M73
<b>Module R</b> It limits harmful voltage on AC coils induced in long lines which causes unwanted making of the relay.		110/240 V AC	M103

① M...R - LED red, M...G - LED green

② When ordering modules indicate their color: gray or black.

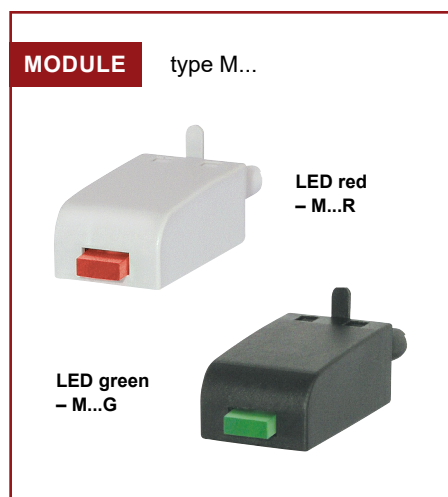

## Interconnection strips ZGGZ80



### ZGGZ80 for:

Plug-in sockets	Relays for plug-in sockets	Interface relays <sup>③</sup>
GZT80	RM84, RM85, RM85 inrush, RM85 105 °C sensitive, RM87L <sup>④</sup> , RM87P <sup>④</sup> , RM87N <sup>④</sup>	PI84-...-TS-... (RM84 + GZT80)
GZM80		PI84-...-MS-... (RM84 + GZM80)
GZS80		PI85-...-TS-... (RM85 + GZT80)
GZT92		(RM85 inrush + GZT80)
GZM92		PI85-...-MS-... (RM85 + GZM80)
GZS92		
ES 32	RM96 1 CO	

<sup>③</sup> Interface relay **PI84 (PI85)** is offered as a **set**: electromagnetic relay **RM84 (RM85)** + plug-in socket **GZT80** or **GZM80** + signalling / protecting module type **M...** + retainer / retractor clip **GZT80-0040** + description plate **GZT80-0035**. <sup>④</sup> Also versions RM87. sensitive

### Interconnection strip ZGGZ80

- designed for the co-operation with plug-in sockets of miniature relays and with interface relays PI84 and PI85, which are equipped with screw terminals; sockets and relays are mounted on 35 mm rail mount acc. to EN 60715,
- bridges common input signals (coil terminals A1 or A2) or output signals - see photo at the top,
- maximum permissible current is 10 A / 250 V AC,
- possibility of connection of 8 sockets or relays,
- colours of strips: **ZGGZ80-1** grey, **ZGGZ80-2** black.

